

GROHE
F-DIGITAL DELUXE
PLANNING &
INSTALLATION GUIDE

GROHE.COM

GROHE
SPA

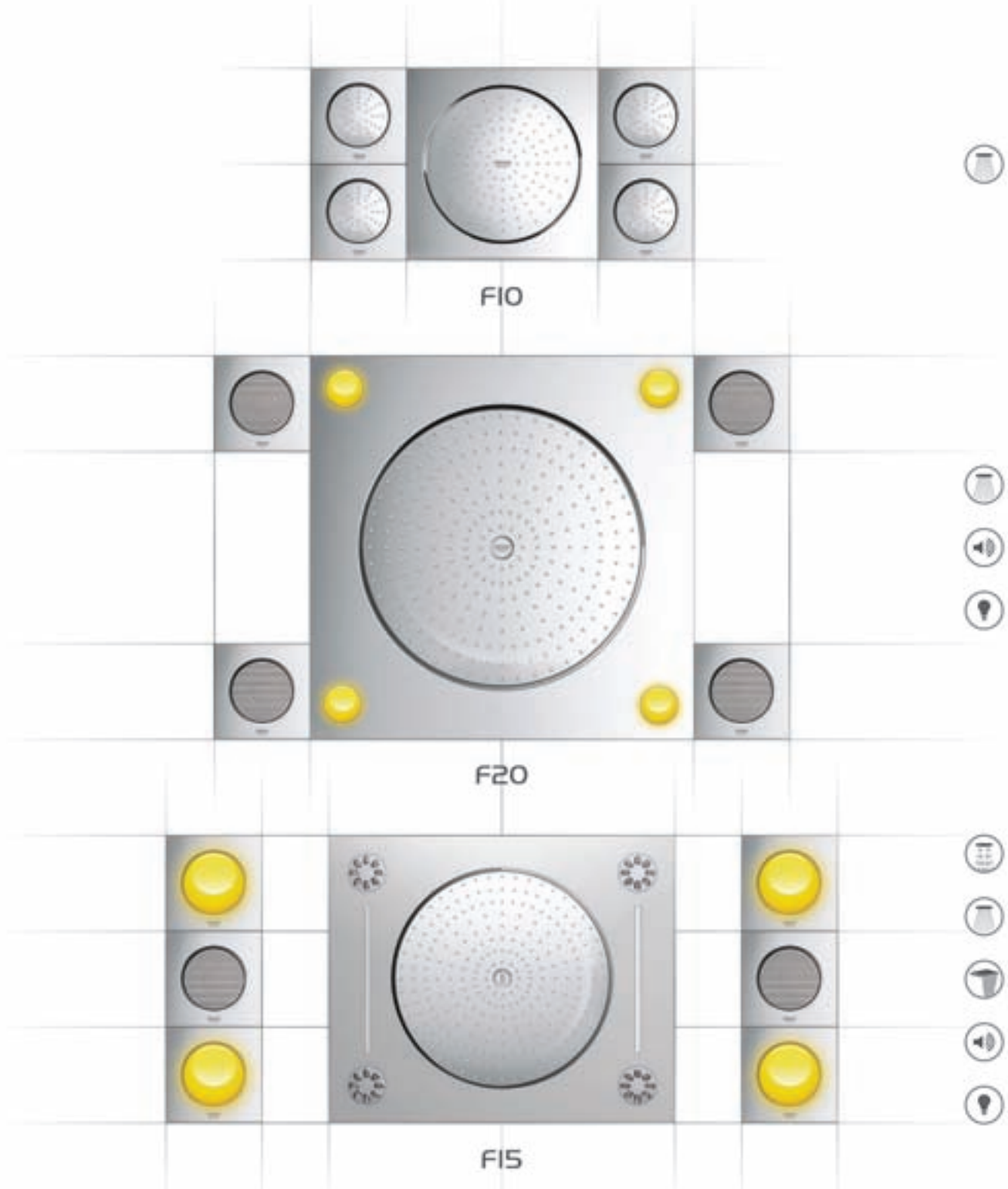

CONTENT

Tailor-Made Showering	4
Important Details	8
Product overview	12
GROHE Shower Configurations	
S	18
M	26
L	34
Recommended Installation Heights	42

SHOWER CONFIGURATION
S

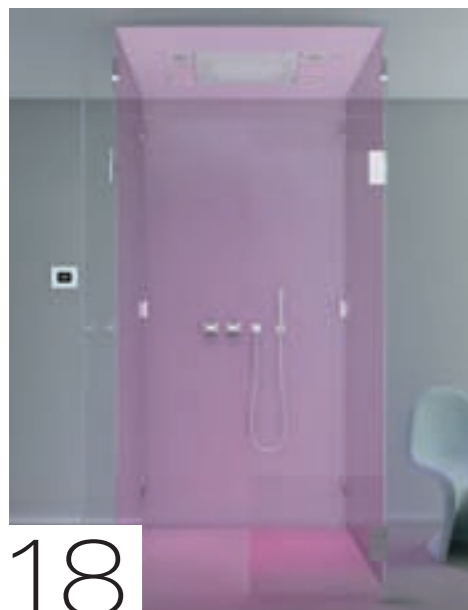

SHOWER CONFIGURATION
M

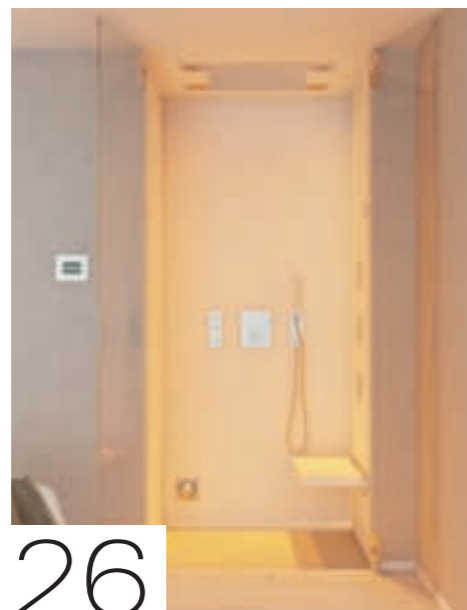

SHOWER CONFIGURATION
L

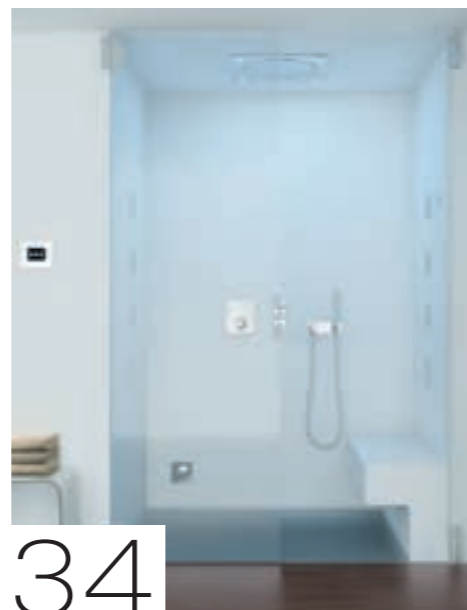

GROHE SPA® TAILOR-MADE SHOWERING

Flexibility for your GROHE SPA®

The bathroom was once merely functional. Today, it's a refuge, a place to refresh and renew. It's a sanctuary from the outside world; a heaven of indulgence. Bathrooms are larger; different zones are now defined. Each is an investment in your health and wellbeing, a place where daily rituals become sensational experiences.

With GROHE SPA®, your home sanctuary can be completely tailor-made – from the basin and bathtub, to the head and hand showers and handles, to the thermostats and light, and the sound and steam. Everything can be made your way. Even down to GROHE Blue® filtered water.





STIMULATE YOUR SENSES

GROHE SPA® F-digital Deluxe: Lights, music, steam... stimulation for all the senses. It's time to transform your bathroom into a luxurious and inspiring home spa.

With the power to fill your shower cabin with different coloured lights, your favourite music of the moment and cleansing steam, F-digital Deluxe is designed to soothe or stimulate all your senses. It is perfect for all your moods. At the touch of a button!

With GROHE SPA® F-digital Deluxe you know your home is a sanctuary, complete with a sophisticated oasis of wellbeing you can control with your fingertips.

Thanks to GROHE SPA® F-digital Deluxe, the bathroom is no longer just a functional space. It is a life-enhancing experience that every day breathes new life into your tired body and soul.

PLANNING A GROHE F-DIGITAL DELUXE STEAM ROOM

IMPORTANT DETAILS!

Please read the following notes before planning and installing a GROHE F-digital Deluxe steamroom!

COORDINATION IS THE KEY

It is important to appoint an experienced supervisor before beginning construction to ensure each stage of the project is correctly carried out. Refer to the planning examples in this document for further details about the correct way to install the water supply, the drain pipes, the electrical cabling and the vapour barrier (if a steam generator is used).

CHOOSING MATERIALS

The materials used for the walls, the ceiling, the furniture and the electrical wiring and appliances must be carefully chosen to withstand 100% humidity.

UNDERSTAND THE INSTALLATION NOTES & LOCAL REGULATIONS

Before work commences, the project supervisor must be familiar with all the general installation notes for GROHE F-digital Deluxe as well as the country-specific regulations concerning construction work, plumbing, electric installation and the Technical Product Information (TPI).

PLAN THE INSTALLATION CAREFULLY

To work correctly digitally operated products need a constant water pressure, water supply and power supply. The hot water supply needs to be above 50°. In some cases, additional installation devices such as pressure-reducing valves or pumps are required to maintain water pressure. The maximum pressure difference between the hot and cold supply must not exceed 0.2 MPa. Make sure the type of wall finish and ceramic finish is suitable for wireless transmission. All the materials between the transmitter and the receiver must be considered. Check the best place for the base unit box and steam generator, especially in relation to the waste outlet, the maximum length (15m) of the steam pipe (copper pipe with a diameter of 15mm), and the need to completely isolate the steam pipe and pressure reducer. GROHE recommends the steam generator is located in a side room for easy maintenance. In addition, a free floor drain/siphon is needed for boiling water after flushing. The drain has to be placed next to the steam generator, but not directly below it to prevent upcoming steam.

ATTENTION:

Please carefully note the different installation depths of the products!

CONSULT A QUALIFIED ELECTRICIANS

As installing steam generators, electronic products and/or electric cables in wet rooms can be hazardous it is important to use a qualified electrician. All products in the GROHE F-digital Deluxe range must be connected using a dedicated circuit that is secured by an appropriate ground fault circuit interrupter (FI)! Please ensure you use an uninterrupted power supply. If this is not possible, GROHE recommends the installation of an uninterruptible power supply (UPS) in accordance with local regulations.

TEST AND CALIBRATE THE SYSTEM

After the system has been installed it is important to check if it is working properly. For the initial operation of the system an iPod touch 4G is needed. Next, the pipes must be flushed, pressurized and checked for leaks. The initial operation steps are described in detail in the TPI provided with the F-digital Deluxe docking station (36 365 000).

INSTRUCT THE CUSTOMER

When the completed steam room is presented, the customer should be instructed in its use and receive a copy of all TPIs.

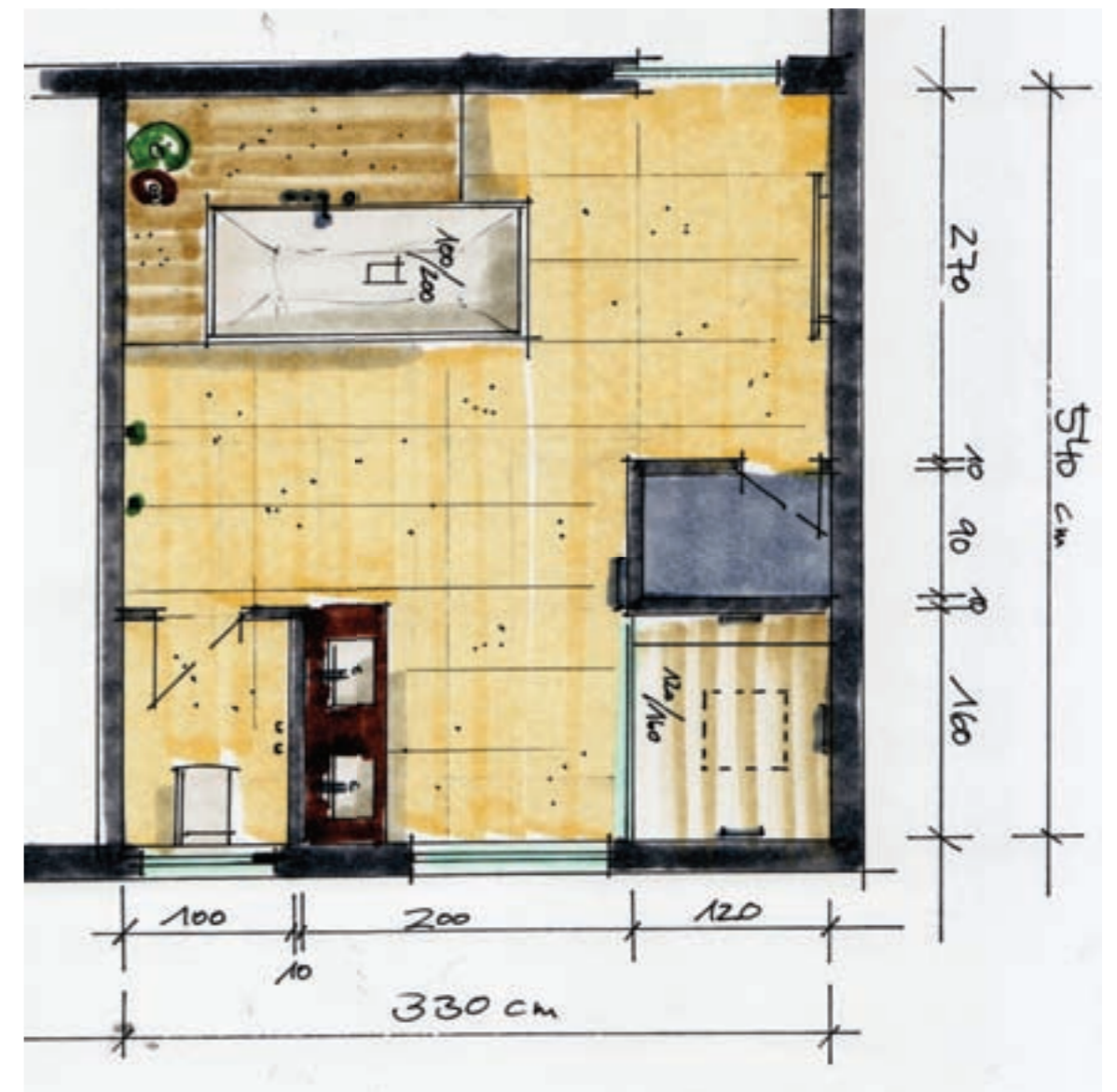

INSTALLING A STEAM SHOWER

IMPORTANT DETAILS!

ATTENTION:

Please note the different installation depths of the products carefully! The wall and ceiling materials, the furniture and the components of the electrical supply must be carefully chosen to cope with 100% humidity. Please integrate a vapour barrier into the design of the steam shower cabin and a humidity resistant seal between the door and ceiling. Please do not use a mosaic that has been glued to a mesh. The roof should have a gradient of 2% running down to the back wall and the tiled stone seats should have a gradient of 1-2% running down from back to front.

To avoid the risk of scalding do not use any metal materials for the seats and storage spaces.

GROHE recommends the steam generator is installed in a separate room for ease of maintenance, maximum safety and to comply with legal and regulatory requirements. A free floor drain or pipe drain siphon for boiling water is also needed next to the steam generator for flushing and decalcification.

To install only light and sound no separate space is needed, but it is important to keep a minimal distance between the SPA Showers Base Unit Box (control unit) and the shower (see VDE 100 Teil 701 or EEC Norm). A locker (36 367 000) can be used to coordinate all cables of the SPA Showers Base Unit Box.

The distance between the Base Unit box and the Docking station should not exceed 4.5m. The power supply should be installed higher than the steam generator and on the opposite of the flushing pipe to avoid contact with water.

Do not direct the steam outlet at a wall, seating or any other object. There should be a free space of at least 70 cm (28") in front of the steam outlet. Place the temperature sensor as far away from the steam outlet as possible. Diagonally opposite is best.

CAUTION!

Stay at least 12" (30 cm) away from hot steam escaping from steam outlet.

Ensure that steam rooms that are used continuously for more than two hours are ventilated by 10–20 cubic meters of air per person an hour. For detailed information see the 'Ventilation' section of the Steam Generator TPIs (36 362 000 or 27 934 000).

THE STEAM GENERATOR

IMPORTANT DETAILS!

Do not make sharp bends or "elbows" along the steam pipe. A minimum radius of 50mm is recommended. Do not allow sags or "water pockets" along the steam pipe and/or ventilation duct. All pipes must be completely isolated.

IMPORTANT!

Prevent any type of obstruction along the steam line, such as a stop-off valve or tap. The internal diameter of the steam pipe must not be reduced. A connector for 15mm copper pipe (soft steel pipe) is included. In countries that do not have this standard, the next higher diameter should be used.

The power supply to the steam generator via the feeder cable must not be broken. For that reason, avoid switches along the feeder cable.

Make sure the flushing pipe slopes all the way down to the waste outlet.

IMPORTANT!

The steam generator's flushing pipe must always discharge into a free drain/siphon outside the steam room itself. The water is very hot (boiling water).

The ambient temperature outside the steam room and around the steam generator must not exceed 35°C.





De-scale the steam generator at regular intervals as instructed (please read the section on 'De-scaling' in the TPI of the relevant GROHE steam generator. In hard-water areas, where calcium levels exceed 5-dH, GROHE recommends the installation of a filter system to avoid scaling.

GROHE SPA® F-DIGITAL DELUXE STIMULATE YOUR SENSES



Architectural freedom to design a unique shower experience

GROHE introduces the F-digital Deluxe, a super-slim and intuitive ambient controller that orchestrates the new collection of products designed to stimulate the senses. By touching the “dry zone” controller you can now choose your own combination of light, sound and steam – three vital elements that have a positive effect on our physical, emotional and spiritual wellbeing. GROHE’s vision of transforming the bathroom from a rational space for cleaning and grooming into an inspiring and emotional Home SPA is now a reality.

 <p style="text-align: right;">1 2</p>	
<p>36 365 000 Docking station for Apple iPod touch 4G* with integrated electronic for data communication</p>	<p>36 368 000 Rough-in set for Docking station</p>
	
<p>36 362 000 Steam generator 2,2 kW 27 934 000 Steam generator 6,6 kW 29 074 000 Rough in Steam generator</p>	<p>47 837 000 Cable extension generator 47 877 000 Cable extension Temp sensor</p>

 <p style="text-align: right;">1 2</p>	
<p>27 865 000 Ceiling Shower F-Series 20" with light, 508 x 508 mm, metal 1 spray pattern: Rain</p>	<p>29 069 000 Cable connection for 27 865 000</p>
	 <p style="text-align: right;">1 2</p>
<p>36 358 000 Base unit box To connect sound, light and steam</p>	<p>36 359 000 Light Set 47 867 000 Cable extension Light 5m 47 910 000 Cable extension Light 1,65m</p>
 <p style="text-align: right;">1 2</p>	<p>36 360 000 Sound Set 47 838 000 Cable extension Sound</p>
	
<p>36 367 000 Rough-in set base unit box</p>	<p>29 072 000 Rough-in set for Light Set</p>
	<p>29 073 000 Rough in Sound modules</p>



* iPod touch* 4G and GROHE SPA® F-digital Deluxe App** are not included in delivery and have to be ordered separately via an authorised Apple store/iTunes store. Apple, the Apple logo, iPod, iPod touch, and iTunes are trademarks of Apple Inc., registered in the U.S. and other countries. Apple is not responsible for the function of this device or device or its compliance with safety and regulatory standards.

PURE FLEXIBILITY SHOWER SOLUTIONS



GROHE SHOWER CONFIGURATIONS

S – M – L

TIPS FOR INSTALLING DIGITAL CONTROLS

For shower installations with a single shower you will need a concealed Digital Thermostatic Mixing unit with one water outlet (THM-Box 1) and a Digital Controller. For shower installations with two or three-shower combinations (e.g. a hand shower, a head shower and side showers) you will need a concealed Digital Thermostatic Mixing unit with three water outlets (THM-Box 3), a Digital Controller and a Digital Diverter.

The Digital Controller/Digital Diverter should be fixed to a solid surface to ensure easy operation. Both are battery powered: 3x CR2450 (3V).

The THM-Box must be installed in a dry and frost protected area. Appropriate revision openings for the THM-Box can be located within the facing of on-the-wall type installation.

In cases where on-the-wall installation is not feasible, appropriate revision openings need to be integrated within the existing construction wall. This type of installation can only be recommended for walls with a minimum thickness of 16cm. The revision opening can also be planned or realised within the wall of side rooms.

The THM-Box includes a transceiver device (Gateway) that is connected to the box with a 3m cable. It is used to ensure optimum communication between the Digital Controller/Digital Diverter and the THM-Box. The distance between the Gateway and the Digital Controller/Digital Diverter should not be more than 5m.

The Gateway can either be installed in a separate revision opening or together with the thermostatic digital mixer unit. The housing of the THM-Box is not waterproof. To avoid damage to the building structure by leaking water or water spilled during maintenance work, the revision floor should have a seal of 10cm height around its perimeter. Alternatively, a drainage connection may also be considered.

The THM-Box can be mounted in any position (e.g. turned by 90° or 180°) as long as the cover is easily accessible. It can be connected either with a 6V plug (65 790 000) or with a 6V built-in (36 078 000) power supply. The 6V plug requires a 230V socket. The appliance must be provided with a dedicated circuit secured by a ground fault circuit breaker.

For safety reasons, the THM-Box should not be positioned in the same area as the power supply. Both power supplies should not be positioned within the area of the THM-Box. Both THM-Boxes come with a 40cm power cable. A 3m extension cable (47 727 000) is available as an addition. Further extension beyond 6m is not recommended for technical reasons. This should be considered in the positioning of the power outlet.



GROHE F-DIGITAL DELUXE CONFIGURATION S

Even in a smaller shower cabin of 120 x 120 cm, you can install a luxurious shower, with GROHE SPA® showers. With two light modules and two sound modules installed in the ceiling, you can enjoy chromotherapy and sound therapy. These modules are complemented by a GROHE Rainshower® F20" ceiling head shower for full-body coverage. Control water flow and temperature with Allure F-digital, equipped with a GROHE TurboStat® thermostatic cartridge. You will reach the desired temperature in a fraction of a second and maintain it for the duration of the shower.

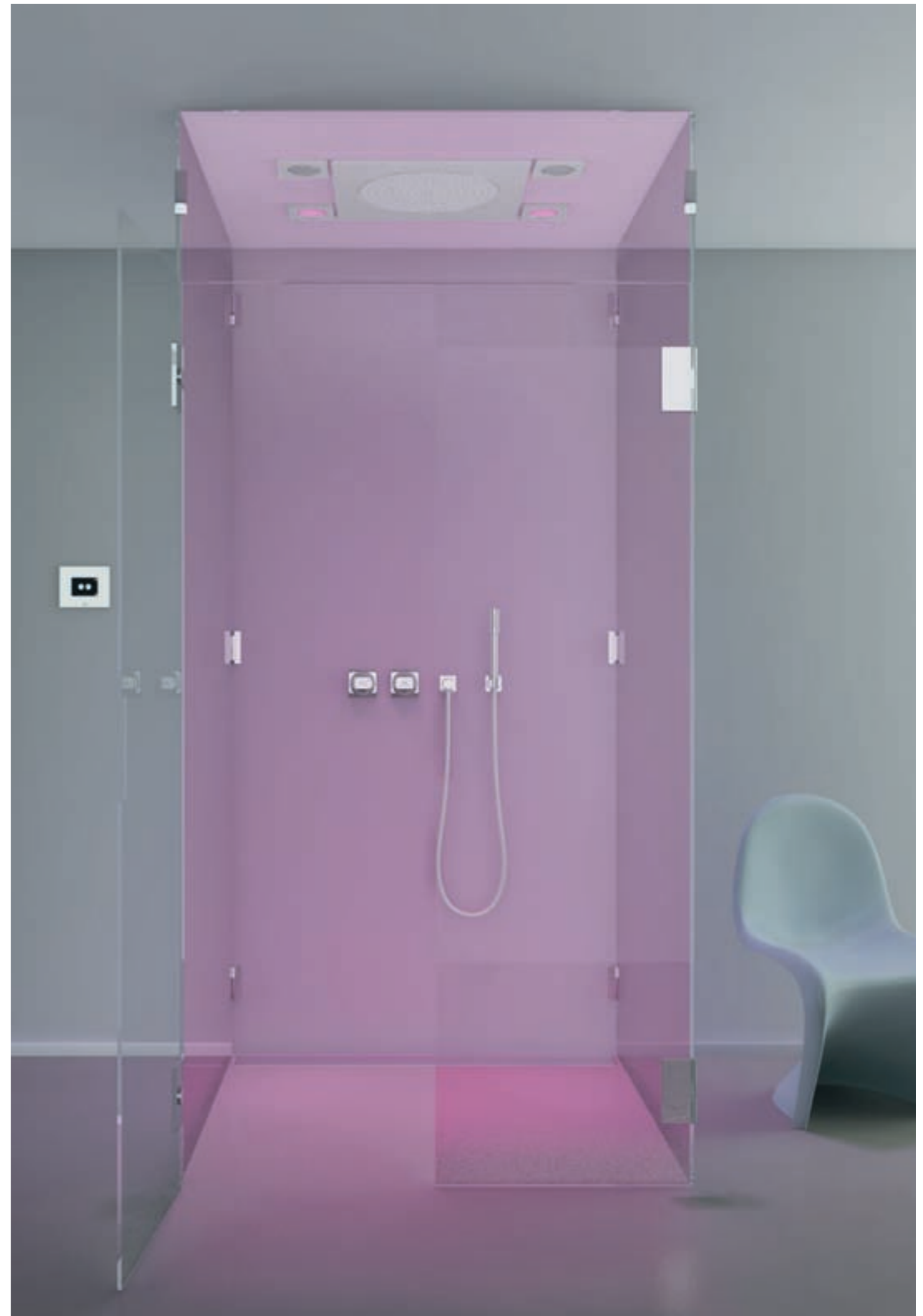

GROHE F-DIGITAL DELUXE CONFIGURATION S

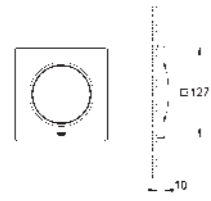

36 359 000
Light set

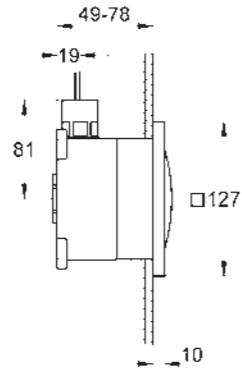

36 360 000
Sound set

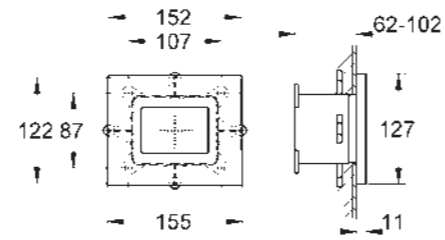

36 365 000
Docking station

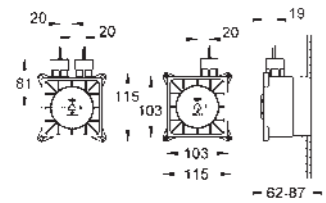

29 072 000
Rough in Light set

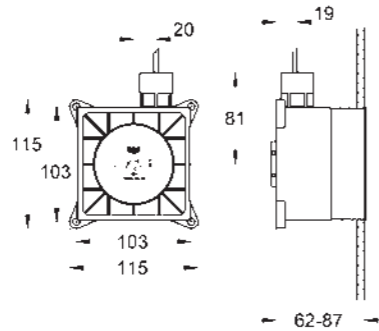

29 073 000
Rough in Sound set

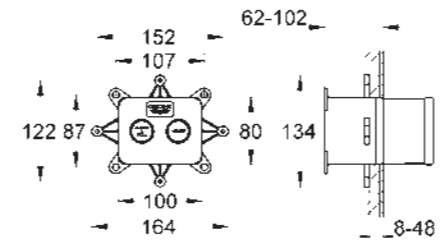

36 368 000
Rough-in set for Docking station

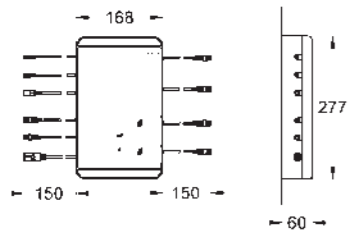

36 358 000
Base unit box

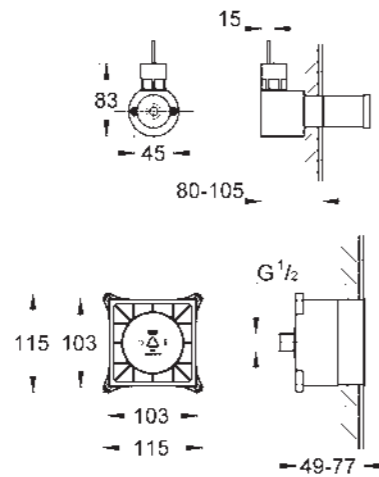

27 286 000
Ceiling shower 20"

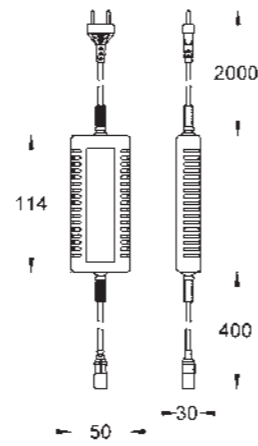

42 429 000
Power supply base unit box

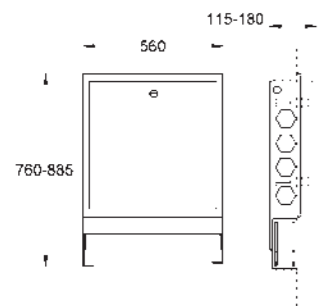

36 367 000
Rough-in set base unit box

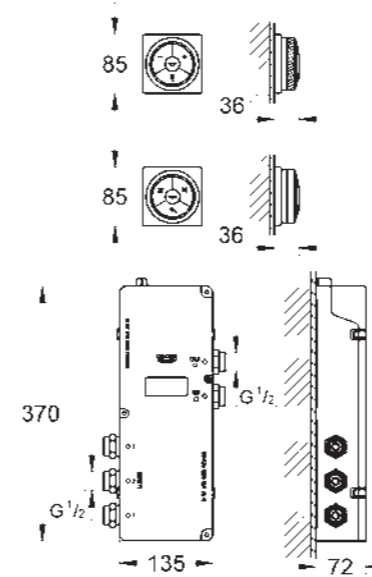

36 352 000
Digital Controller and
Digital Diverter for shower

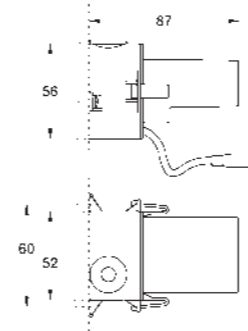

36 078 000
Plug power supply 110-240 V

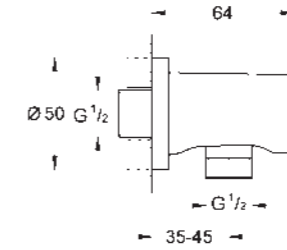

27 076 000
Rainshower®
Shower outlet elbow

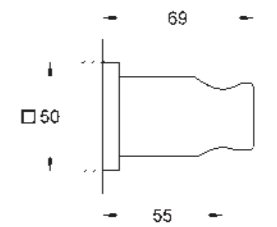

27 075 000
Rainshower®
Wall hand shower holder

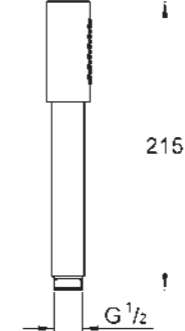

28 034 000
Sena Hand shower

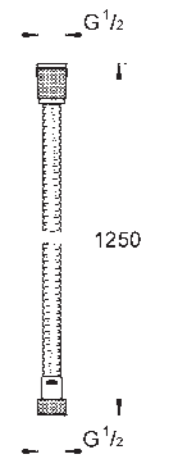

28 142 000
Relexa Metal shower hose

GROHE F-DIGITAL DELUXE CONFIGURATION S

BARE BRICKWORK



SIZE OF THE SHOWER CABIN: 1.20 x 1.20m
ROOM HEIGHT: 2.50m

INSTALLATION HEIGHT:

- water controls: 1.15m
- docking station: 1.45m

For better understanding and visualization a corner situation is used.
The maximum distance from Steam generator to Base unit box should not exceed 4.5m.

ATTENTION:

Please note the different installation depths of the products carefully!

DUCTWORK FOR CABLES



Install all concealed boxes; please see installation heights on page 43.

Ductwork for cables has to be used for all electrical connections from the concealed boxes to the base unit box (ductwork diameter 21mm).

ATTENTION:

At each side of the cable an excess length of 20cm is needed. Additionally corners and curves have to be added to total length!

ATTENTION:

Avoid bends in cables and too close-rounded edges.

LIGHTWEIGHT WALL CONSTRUCTION



Overview of the lightweight wall construction for the shower and the side room.

Fixing plate for docking station.

Place the locker for the Base unit box in the side room and fix it to the ground floor.

DUCTWORK WITH CABLES + PIPE INSTALLATION



To connect the modules easily please ensure the cables have an excess length of at least 20cm for the concealed boxes.

MAXIMUM LENGTH FOR LIGHT & SOUND:
10m (5m included in delivery).

MAXIMUM LENGTH FOR THE DOCKING STATION
TO BASE UNIT BOX:
4.50m (included in delivery).

LIGHT MODULES:

Connection from Base unit box to lamp 1:
Loop through from lamp 1 (two ductwork connectors)
to lamp 2 (one ductwork connector).

SOUND MODULES: Connect Y connector to the Base unit box, split each pair of sound modules and place them opposite to each other in the SPA cabin.
Install all the other concealed boxes for water controls and side showers and install pipes for water supply.

GROHE F-DIGITAL DELUXE CONFIGURATION S

PIPE INSTALLATION



To connect the modules easily please ensure the cables have an excess length of at least 20cm for the concealed boxes and 10cm in the locker.

MAXIMUM LENGTH FOR LIGHT & SOUND:
10m (5m included in delivery).

MAXIMUM LENGTH FOR THE DOCKING STATION
TO BASE UNIT BOX:
4.50m (included in delivery).

LIGHT MODULES:

Connection from Base unit box to lamp 1: Loop through from lamp 1 (two ductwork connectors) to lamp 2 (one ductwork connector).

SOUND MODULES:

Connect Y connector to the Base unit box, split each pair of sound modules and place them opposite to each other in the SPA cabin.

Install all the other concealed boxes for water controls and side showers and install pipes for water supply.

FRONTAL VIEW



Connection of all single modules with the base unit box of configuration S, including power supply (1 power supply with a 2 x 1 light module and 2 x 1 sound module).

SIDE ROOM



The revised floor of the THM should have a 10cm-high seal around its perimeter. Alternatively, a drainage connection may also be considered.

WALL COVERING



While covering the walls ensure the overhanging cable ends remain in position; otherwise connection of the modules is not possible.
Please install each module in the concealed boxes and connect them according to the corresponding TPIs.
For initial operation of the SPA shower cabin an iPod touch 4G is needed; it is not included with any GROHE F-digital Deluxe product.

GROHE F-DIGITAL DELUXE CONFIGURATION M

In a bigger room of 120 cm, you have enough room to install a small bench and the chance to enjoy luxurious steam therapy, with the GROHE F-digital Deluxe steam generator. The three Rainshower® F5" side showers on the right side are complemented by the F5" sound and light modules for a real stereo aqua visual and sound effect. Combine the showers with the powerful and flexible Grohtherm F mechanical water controls – always the right temperature – and a Sena hand shower.

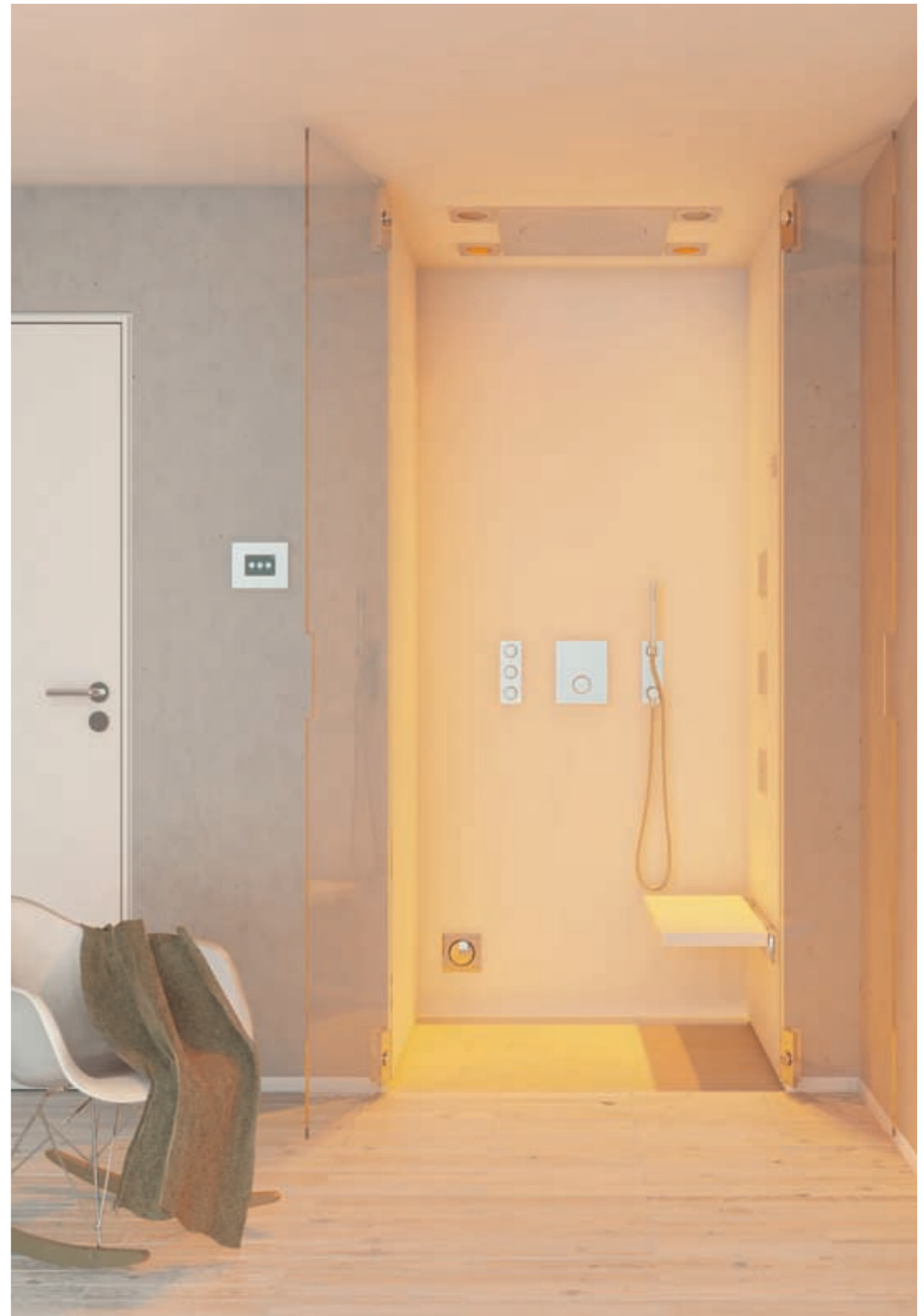

GROHE F-DIGITAL DELUXE CONFIGURATION M

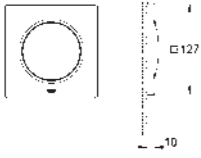
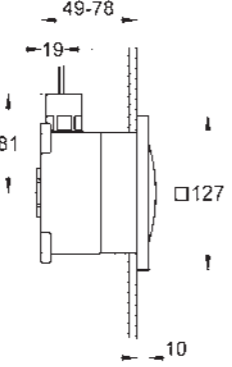
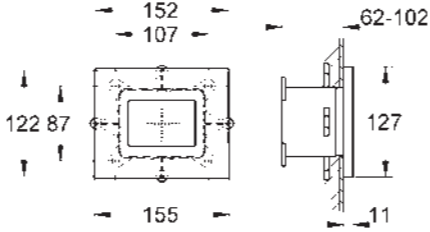
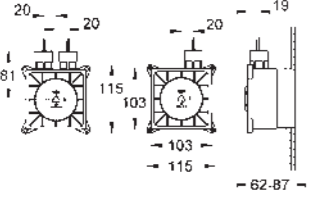
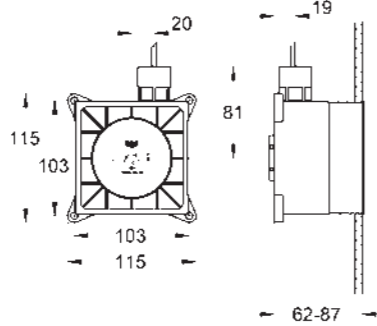
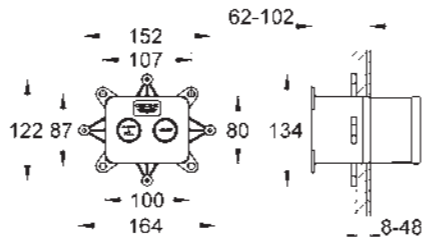
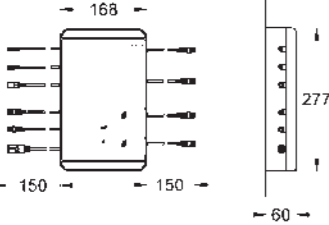
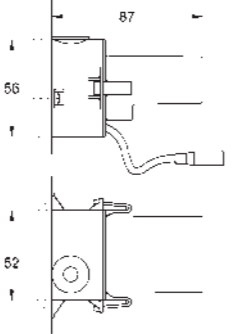
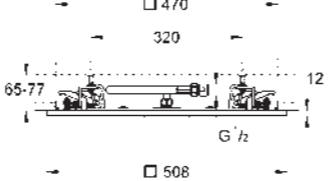
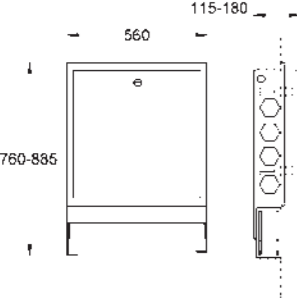
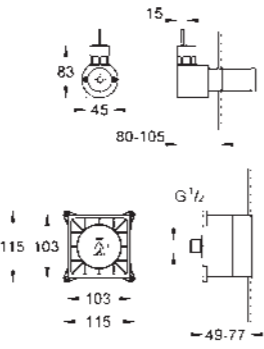
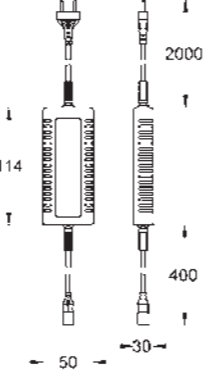
 <p>36 359 000 Light set</p>	 <p>36 360 000 Sound set</p>	 <p>36 365 000 Docking station</p>
 <p>29 072 000 Rough in Light set</p>	 <p>29 073 000 Rough in Sound set</p>	 <p>36 368 000 Rough-in set for Docking station</p>
 <p>36 358 000 Base unit box</p>	 <p>36 362 000 Steam generator 2.2 kW with steam outlet and temperature sensor</p>	 <p>27 286 000 Ceiling shower 20"</p>
 <p>36 367 000 Rough-in set base unit box</p>	 <p>29 074 000 Rough - in set steam generator</p>	 <p>42 429 000 Power supply base unit box</p>

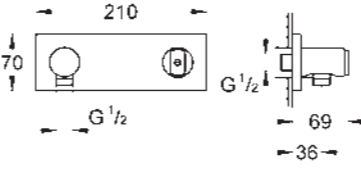
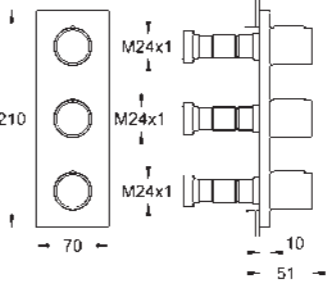
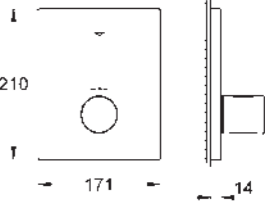
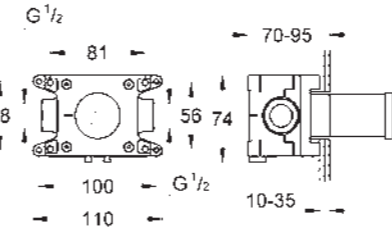
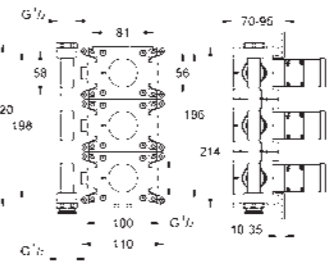
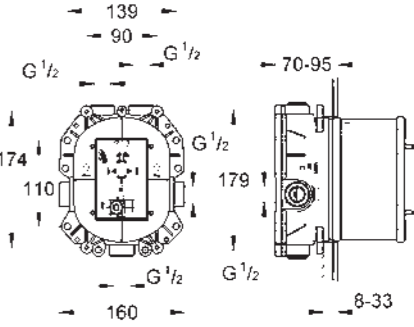
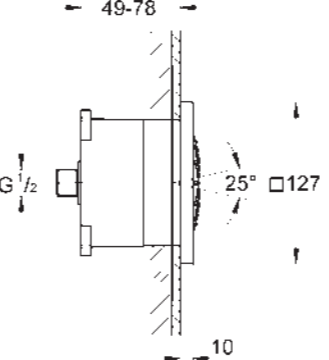
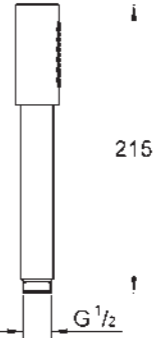
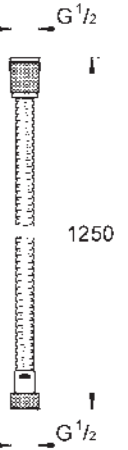
 <p>27 621 000 Wall shower union with integrated shower holder</p>	 <p>27 625 000 Triple volume control trim</p>	 <p>27 619 000 Thermostatic trim</p>
 <p>35 034 000 Rough-in for wall shower union 27 621 000</p>	 <p>35 031 000 Rough-in for triple volume control 27 625 000</p>	 <p>35 500 000 Universal thermostatic mixer for concealed installation</p>
 <p>27 251 000 Side shower 5"</p>	 <p>28 034 000 Sena Hand shower</p>	 <p>28 142 000 Relaxa Metal shower hose</p>

GROHE F-DIGITAL DELUXE CONFIGURATION M

BRICKWORK



SIZE OF THE SHOWER CABIN: 121 x 0.9m
ROOM HEIGHT: 2.50m

To comply with local legal regulations GROHE recommends a side room for the steam generator and the base unit box; it should have a free floor drain/siphon.

INSTALLATION HEIGHTS:

- water controls: 1.15m.
- docking station: 1.45m.
- side showers from ground: 0.85m, 1.15m and 1.45m.
- steam outlet: 0.2m and 0.15m from side wall.
- temperature sensor: 1.75 m
(with maximum distance to steam outlet).

The maximum distance from Steam generator to Base unit box should not exceed 4.50m.

ATTENTION:

Please note the different installation depths of the products carefully!

DUCTWORK FOR CABLES



Install all concealed boxes; see installation heights on page 43.

Ductwork for cables has to be used for all electrical connections from the concealed boxes to the base unit box (ductwork diameter 21mm).

ATTENTION:

At each side of the cable an excess length of 20cm is needed. Additionally corners and curves have to be added to total length!

ATTENTION:

Avoid bends in cables and too close-rounded edges.

LIGHTWEIGHT WALL CONSTRUCTION



Overview of the lightweight wall construction for the shower and the side room.

Fixing plates for docking station, steam outlet, temperature sensor, water controls & side showers. Place the locker for the Base unit box in the side room and fix it to the floor.

DUCTWORK WITH CABLES



For an easy connection of the modules ensure the cables have at least an excess length of 20cm for the concealed boxes.

MAXIMUM LENGTH LIGHT & SOUND:

10m (5m included in delivery)

MAXIMUM LENGTH DOCKING STATION TO BASE UNIT BOX:

4,50m (included in delivery)

LIGHT MODULES:

Connection from Base unit box to lamp 1.
Loop through from lamp 1 (two ductwork connectors)
to lamp 2 (one ductwork connector).

SOUND MODULES:

Connect Y connector to the Base unit box, split each pair of sound modules and place them opposite to each other in the SPA cabin.

GROHE F-DIGITAL DELUXE CONFIGURATION M

PIPE INSTALLATION



Install concealed boxes for water controls and side showers. Connect the warm and cold water and install pipes for water supply.

For installation heights please see table on page 43.

ATTENTION:

Please do not forget to integrate a vapour barrier!

View from the right side



FRONTAL VIEW BASE UNIT BOX



Connections of all single modules with the base unit box of configuration M, including power supply (1 power supply with 2 x 1 single light module and 2 x 1 single sound module).

UTILITY ROOM



Overview of the utility room, including steam generator and base unit box.

The steam generator has to be placed where it is accessible for maintenance.

In addition, a free floor drain/siphon is needed for boiling water after flushing. The drain must be placed next to the steam generator but not directly below it to prevent upcoming steam. All pipes must be completely isolated.

WALL COVERING

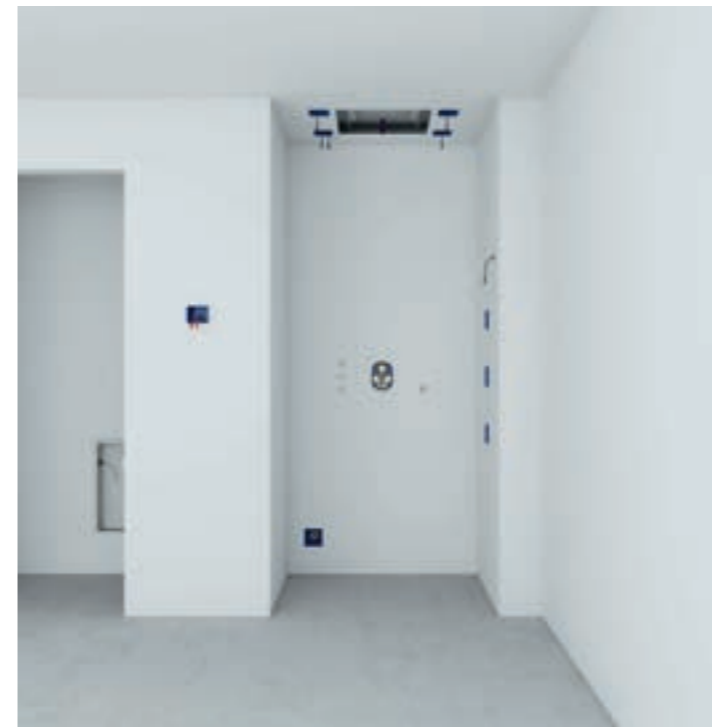

While wall covering is carried out, please ensure the overhanging cable ends remain in position; otherwise connection of the modules is not possible.

Please install each module in the concealed boxes and connect them according to the relevant TPIs.

For initial operation of the SPA shower cabin an iPod touch 4G is required; it is not included with any GROHE F-digital Deluxe product.

GROHE F-DIGITAL DELUXE CONFIGURATION L

If you have the space, why not build a 160 cm-wide XL shower? Use the extra space for a full-width bench on which to enjoy the water, light, sound and steam from F-digital Deluxe together. With two speakers in the shower room and two outside, you can also listen to your music outside the shower. Experience true 3D showering with the luxurious Rainshower® ceiling shower 20" with light and six side showers. The reliable and accurate Grohtherm F thermostatic controls steer all the different sprays as well as the Sena hand shower.

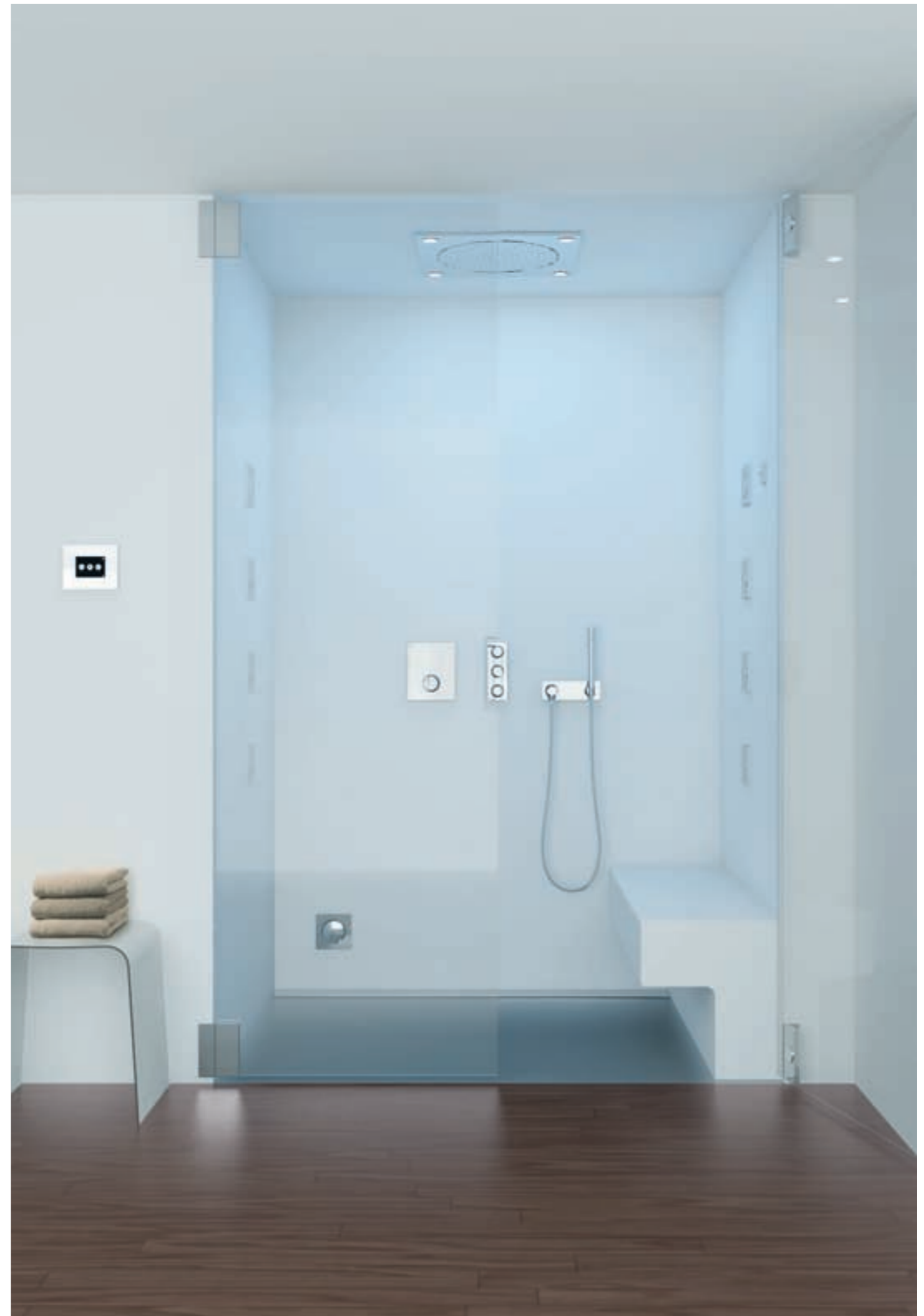

GROHE F-DIGITAL DELUXE CONFIGURATION L

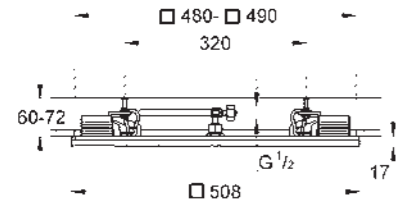

27 865 000
Ceiling shower with light

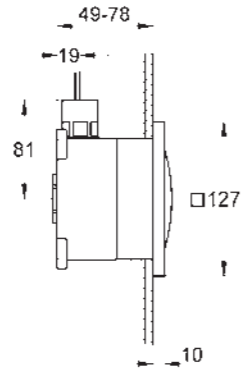

36 360 000
Sound set

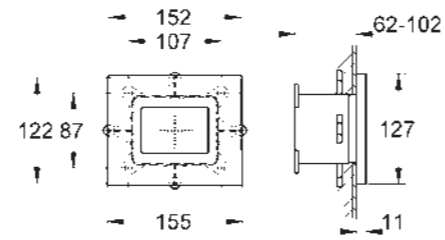

36 365 000
Docking station

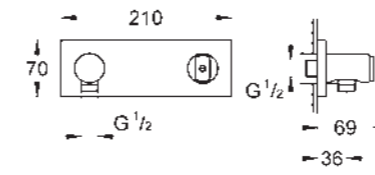

27 621 000
Wall shower union
with integrated shower holder

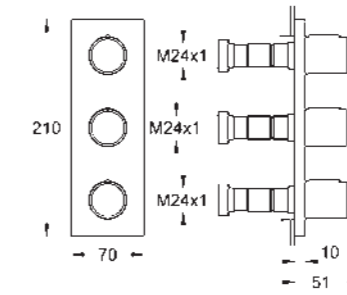

27 625 000
Triple volume control trim

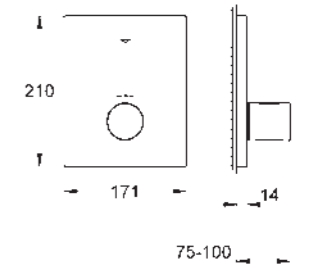

27 619 000
Thermostatic trim

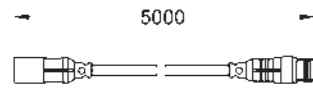

29 069 000
Connection set for Ceiling shower with light

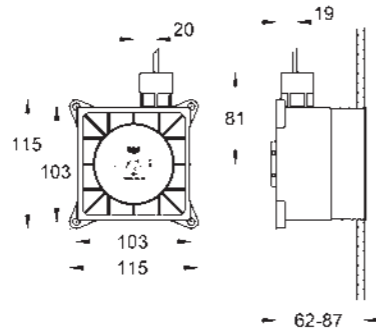

29 073 000
Rough in Sound set

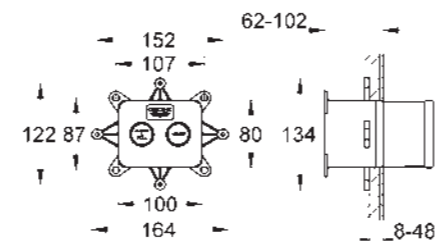

36 368 000
Rough-in set for Docking station

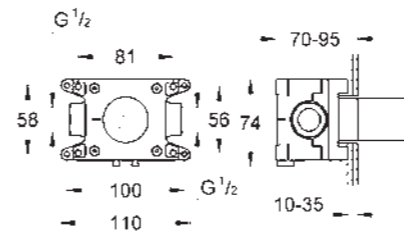

35 034 000
Rough-in for wall shower union
27 621 000

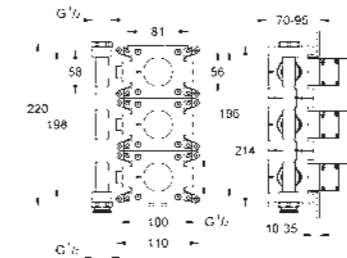

35 031 000
Rough-in for triple volume control
27 625 000

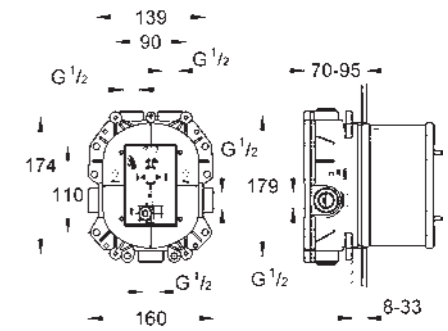

35 500 000
Universal thermostatic mixer
for concealed installation

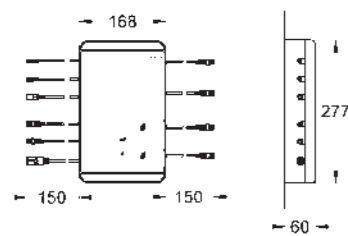

36 358 000
Base unit box

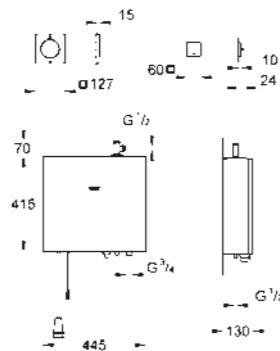

27 934 000
Steam generator 6.6 kW
with steam outlet and temperature sensor

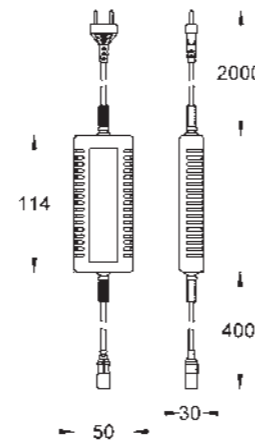

42 429 000
Power supply base unit box

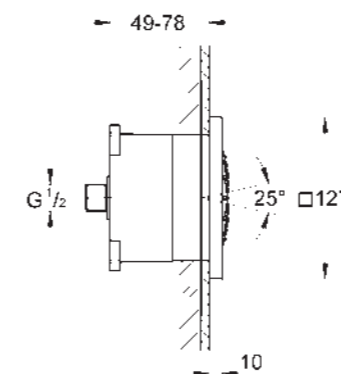

27 251 000
Side shower 5"

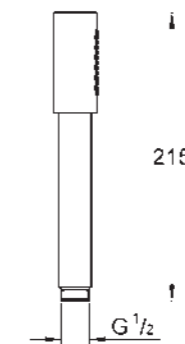

28 034 000
Sena Hand shower

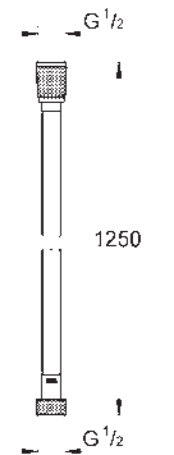

28 362 000
Shower hose Silverflex

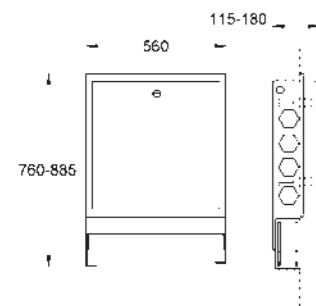

36 367 000
Rough-in set base unit box

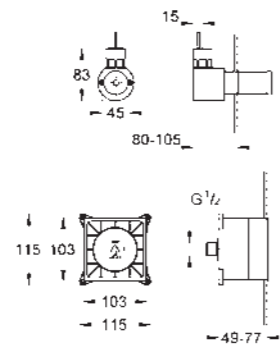

29 074 000
Rough - in set steam generator

GROHE F-DIGITAL DELUXE CONFIGURATION L

BARE BRICKWORK

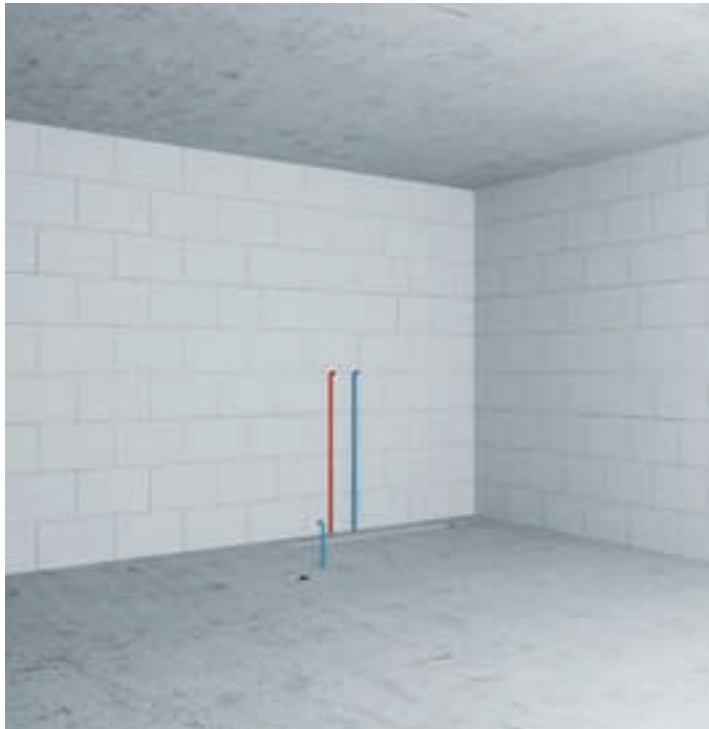

SIZE OF THE SHOWER CABIN: 1.60 x 1.20m
ROOM HEIGHT: 2.50m

To comply with local legal regulations GROHE recommends a side room is used for the Steam generator and the base unit box; it should have a free floor drain/siphon.

INSTALLATION HEIGHTS:

- water controls: 1.15m.
- docking station: 1.45m.
- side showers from ground: 0.85m, 1.15m and 1.45m.
- sound modules: 1.75m.
- steam outlet: 0.2m and 0.2 m from side wall.
- Temperature sensor: 1.75 m
(with maximum distance to steam outlet).

The maximum distance from Steam generator to Base unit box should not exceed 4.50m.

ATTENTION:

Please note the different installation depths of the products carefully!

DUCTWORK FOR CABLES



Install all concealed boxes; please see installation heights on page 43.

Ductwork for cables has to be used for all electrical connections from the concealed boxes to the base unit box (ductwork diameter 21mm).

ATTENTION:

At each side of the cable an excess length of 20cm is needed. Additionally corners and curves have to be added to total length!

ATTENTION:

Avoid bends in cables and too close-rounded edges.

LIGHTWEIGHT WALL CONSTRUCTION



Overview of the lightweight wall construction for the shower and the side room.

Wooden base for the side showers, sound modules above, docking station, water controls as well as the steam outlet and temperature sensor above the side showers on the right side. Place the locker for the Base unit box in the side room and fix it to the floor.

DUCTWORK WITH CABLES



For an easy connection of the modules ensure cables have an extra 20cm for the concealed boxes.

MAXIMUM LENGTH LIGHT & SOUND:
10m (5 m included in delivery).

MAXIMUM LENGTH DOCKING STATION
TO BASE UNIT BOX:
4.50m (included in delivery).

LIGHT MODULES:

Connection from Base unit box to lamp 1.
Loop through from lamp 1 (two ductwork connectors) to lamp 2 (one ductwork connector).

SOUND MODULES:

Connect Y connector to the Base unit box, split each pair of sound modules and place them opposite to each other in the SPA cabin.

GROHE F-DIGITAL DELUXE CONFIGURATION L

PIPE INSTALLATION



Install all other concealed boxes for water controls and side showers.
Connect the warm and cold water and install pipes for water supply.
For installation heights please see table on page 43.

ATTENTION:

Please do not forget to integrate a vapour barrier!

View from the right side



FRONTAL VIEW

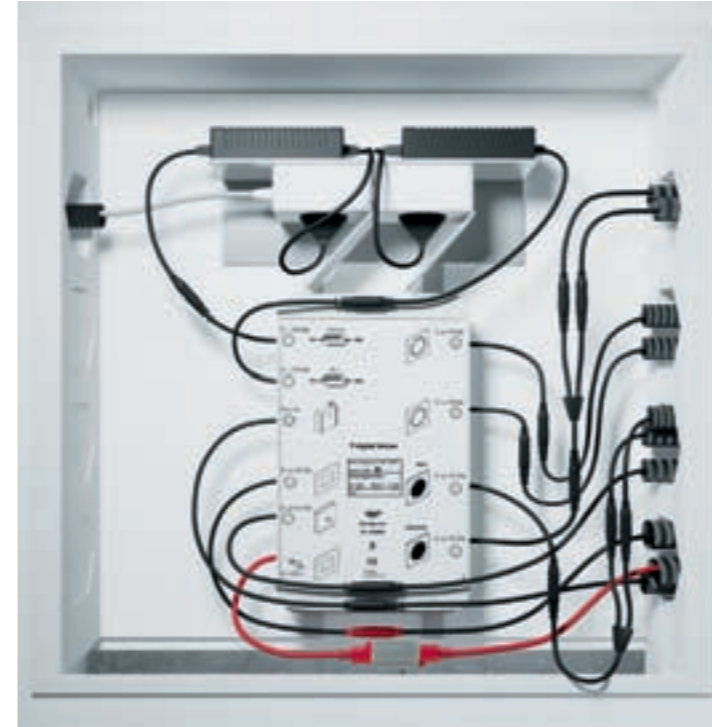

Connection of all single modules with the base unit box of configuration L, including power supply (2 power supplies with 4 x 1 single light modules and 2 x 1 single sound modules).

UTILITY ROOM



Overview of the utility room, including steam generator and base unit box.
The steam generator has to be placed where it is accessible for maintenance.
In addition, a free floor drain/siphon is needed for boiling water after flushing.
The drain must be placed next to the steam generator but not directly below it to prevent upcoming steam.
All pipes must be 100% isolated.

WALL COVERING



While covering the wall take care to leave the overhanging cable ends in position; otherwise connection of the modules is not possible.
Please install each module in the concealed boxes and connect them according to the relevant TPIs.
For initial operation of the SPA shower cabin an iPod touch 4G is required; it is not included with any GROHE F-digital Deluxe product.

INSTALLATION INSTRUCTIONS FOR ACCESSORIES

Basin set	Recommended height*
Mirror	1100 - 1250 mm
Shelf	1150 - 1250 mm
Glass holder	1150 - 1250 mm
Soap dish	950 - 1050 mm
Soap dispenser	950 - 1050 mm
Towel ring	900 - 1000 mm
Towel rail	850 - 950 mm
Basin leading edge	850 mm

WC set	Recommended height*
Toilet roll holder	700 - 800 mm
Spare toilet roll holder	200 - 250 mm
Toilet brush set	200 - 250 mm
from the floor mounting hight of WC without lid	400 mm

Bath set	Recommended height*
Towel rail 600/800 mm	1550 - 1750 mm
Robe hook	1550 - 1750 mm
Soap dish	100 - 350 mm **
Soap dispenser	100 - 350 mm **
Grip 300 mm	70 - 150 mm **

Bidet set	Recommended height*
Towel ring	900 - 950 mm
Soap dish	650 - 750 mm

Shower set	Recommended height*
Towel rail 600/800 mm	1550 - 1750 mm
Robe hook	1550 - 1750 mm
Soap dish	1200 - 1500 mm
Soap dispenser	1200 - 1500 mm
Grip 300 mm	1200 - 1500 mm



RECOMMENDED INSTALLATION HEIGHT FOR SHOWERS

DESCRIPTION	SHOWER INSTALLATION HEIGHT (CM)					
	H	150	160	170	180	190
Body height	H	150	160	170	180	190
Water controls	h0	105	115	120	125	130
Side shower	h1	60	70	70	75	80
Side shower	h2	95	105	110	115	120
Side shower	h3	130	140	150	155	160
Temperature sensor	h4	150	160	170	180	190
Head shower	h5	200	210	225	235	250

- H = body height
- h0 = height of the Water controls
- h1 = height of the knee shower
- h2 = height of the hip shower
- h3 = height of the shoulder shower
- h4 = height of the temperature sensor
- h5 = height of the head shower

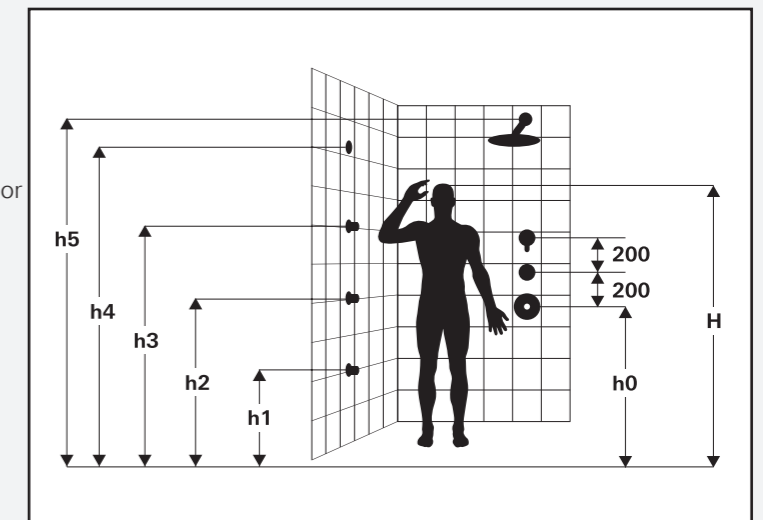

barrier free installation height of controller / diverter: 115 cm

* Measured from the flooring ** Measured from the bath rim

Grohe AG
Feldmühleplatz 15
40545 Düsseldorf/Germany
Phone: +49 (0) 211 / 91 30 - 30 00

For more information on our award-winning designs
go to www.grohe.com

05/2013 - Copyright by GROHE